

# Progress with layout studies

---

- Agreed in Glasgow that studies of proposed layouts needed – will these satisfy our physics requirements?
- After discussion with various experts, settled on FATRAS as best of ATLAS tools.
- Incorporates (simplified) geometry, allows running of pattern recognition.
- Two problems:
  - ◆ Making FATRAS work at all!
  - ◆ Introducing required geometry for upgrade.
- Try first to get FATRAS functioning with Utopia layout, then try alternative geometries.
- Utopia layout, screen shot:

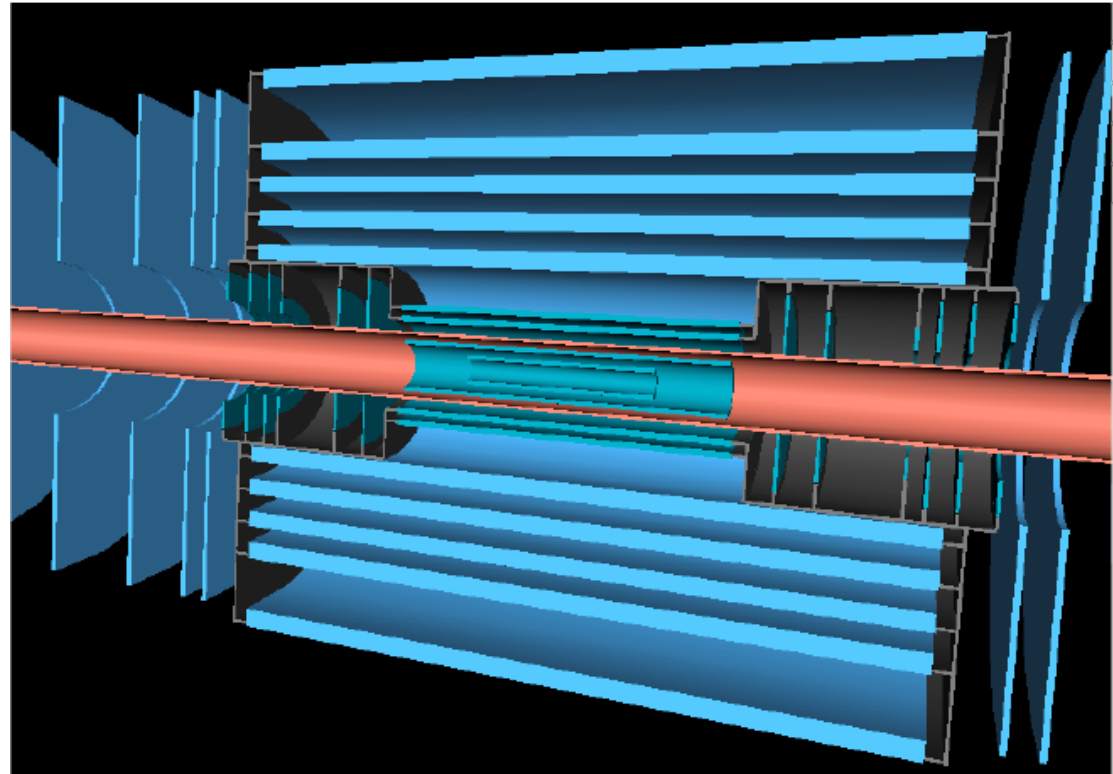

# Utopia layout

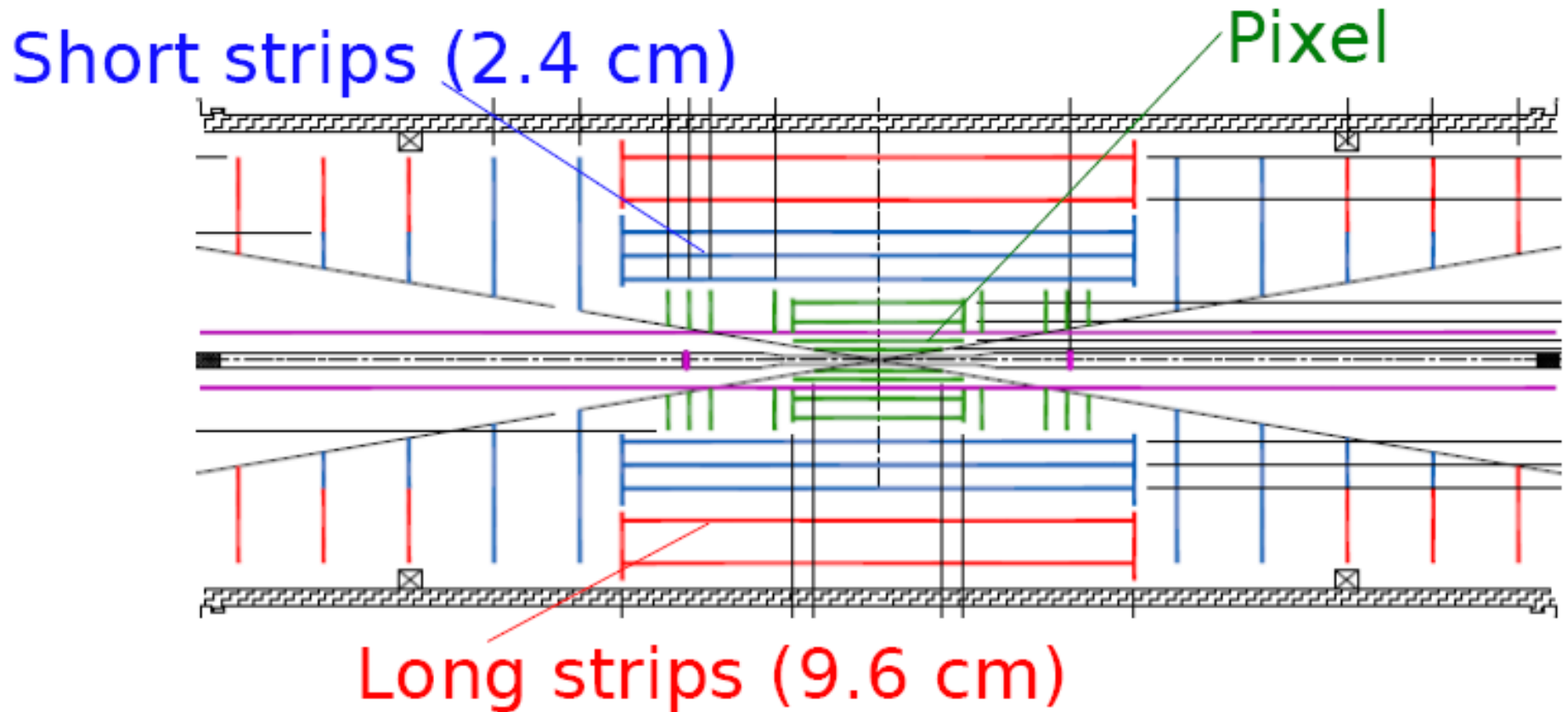

# 100 GeV muons

- Number of hits (results produce by Barry King).

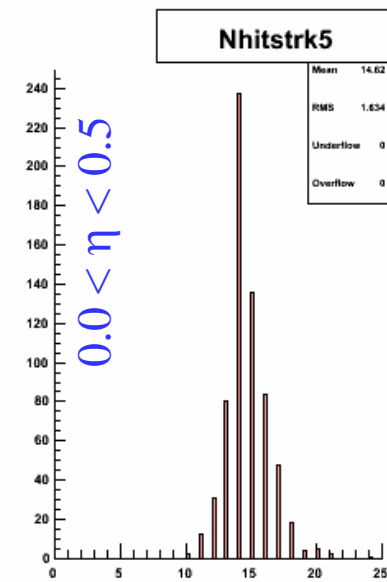
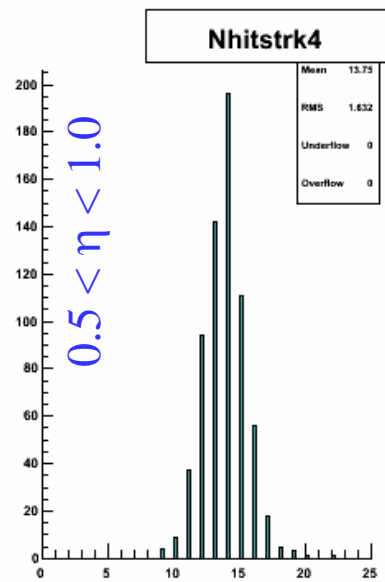
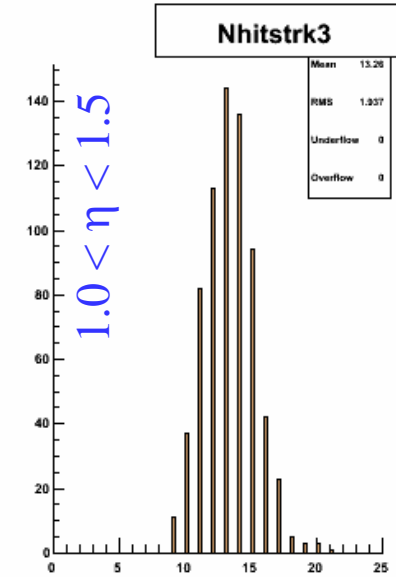
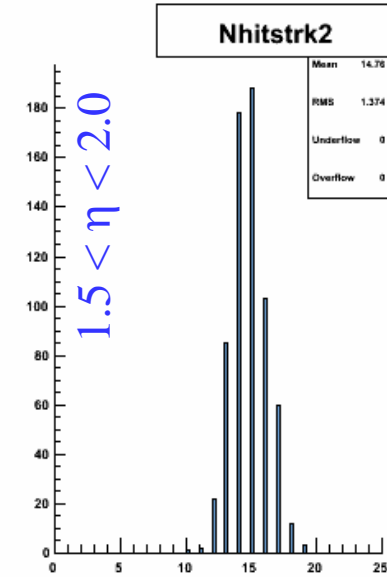
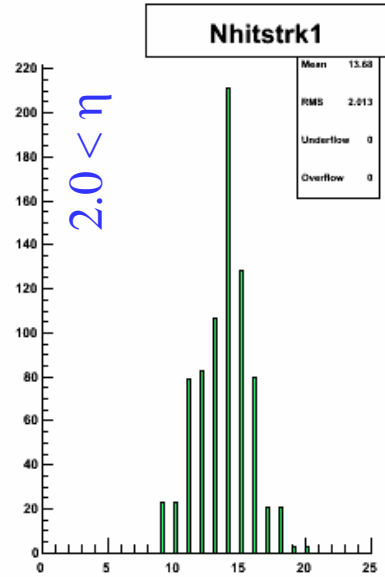

# 100 GeV electrons

- Number of hits.

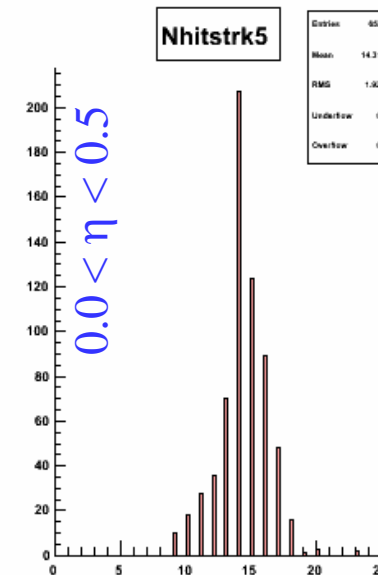
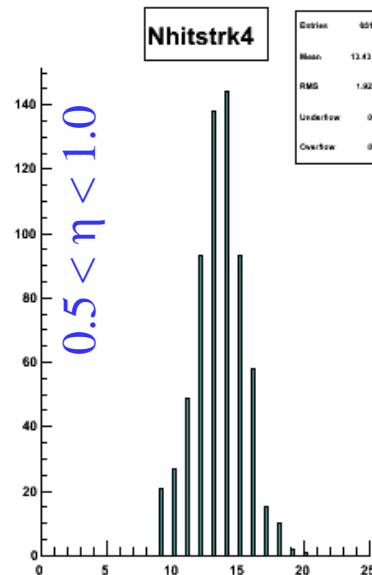
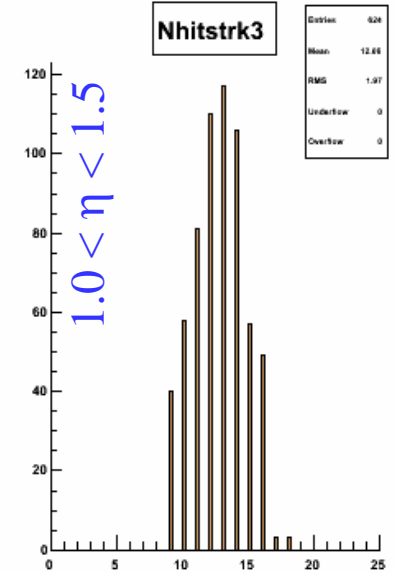
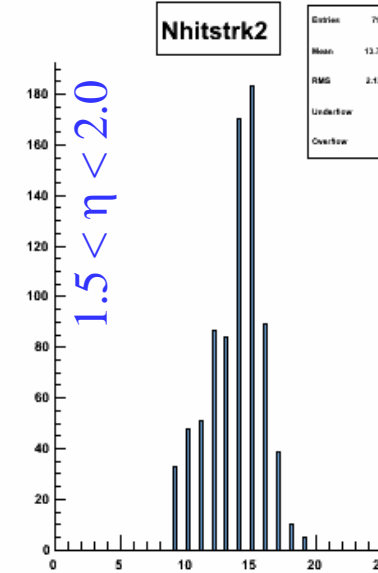
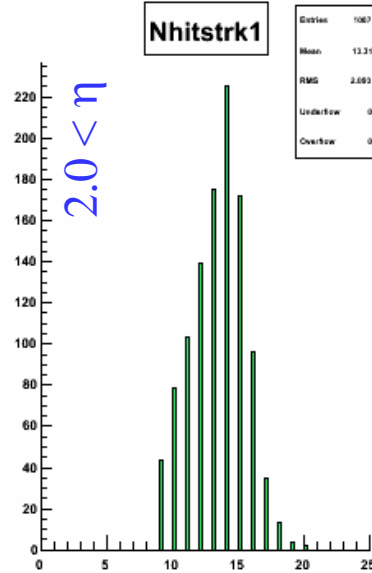

# 100 GeV muons

- $p_T$  resolution.
- In central region:

$$\frac{\sigma_{p_T}}{p_T} = 0.02.$$

- In forward region:

$$\frac{\sigma_{p_T}}{p_T} = 0.08.$$

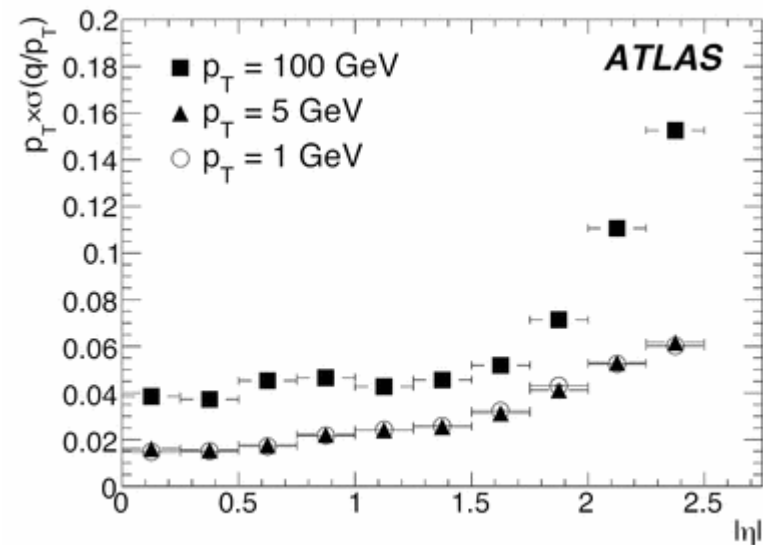
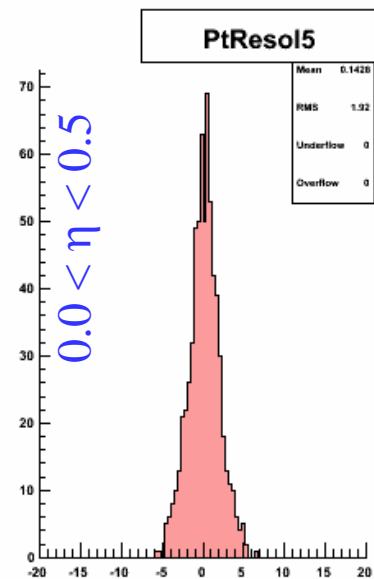
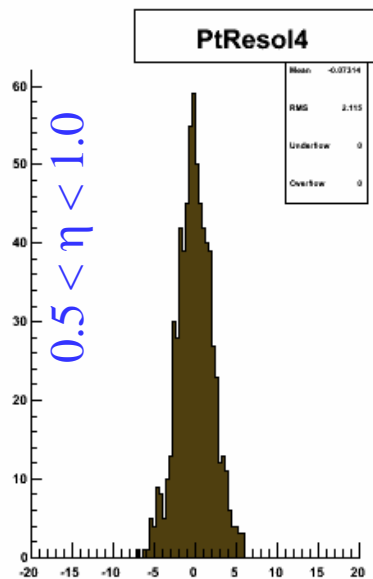
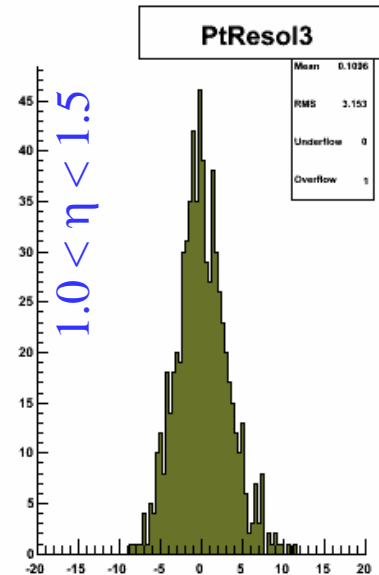
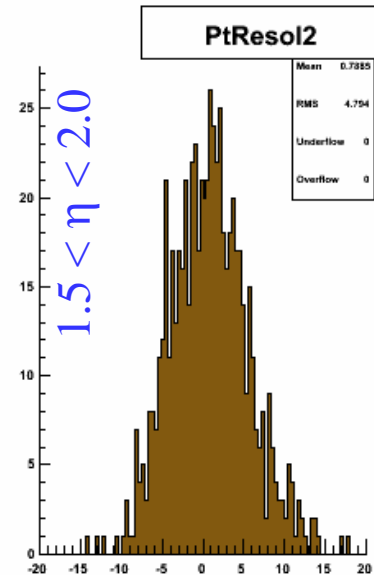
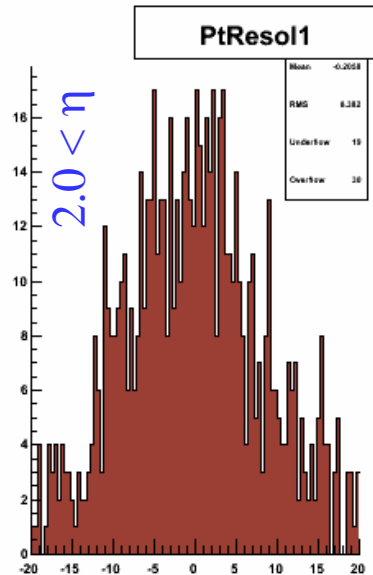

# 5 GeV muons

- $p_T$  resolution.
- In central region:

$$\frac{\sigma_{p_T}}{p_T} = 0.02.$$

- In forward region:

$$\frac{\sigma_{p_T}}{p_T} = 0.03.$$

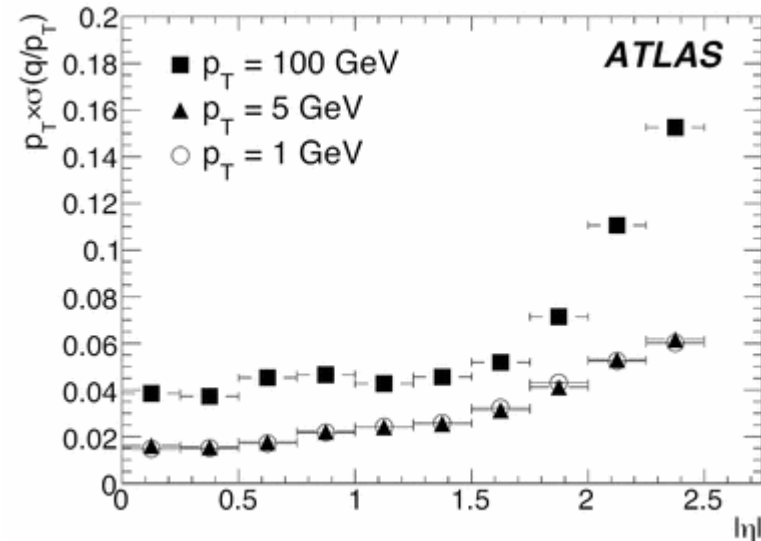
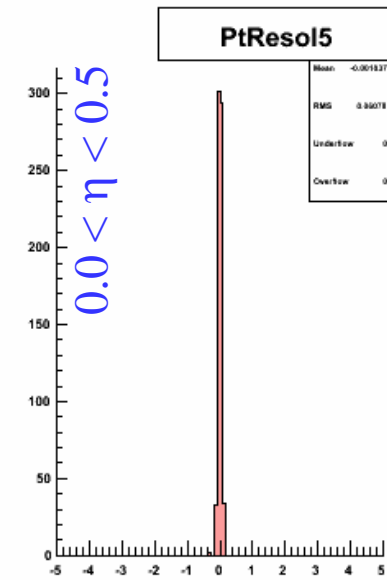
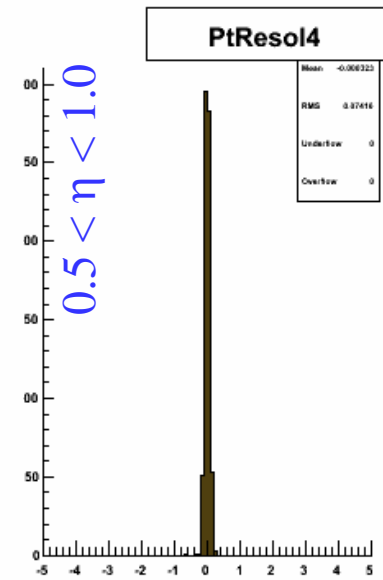
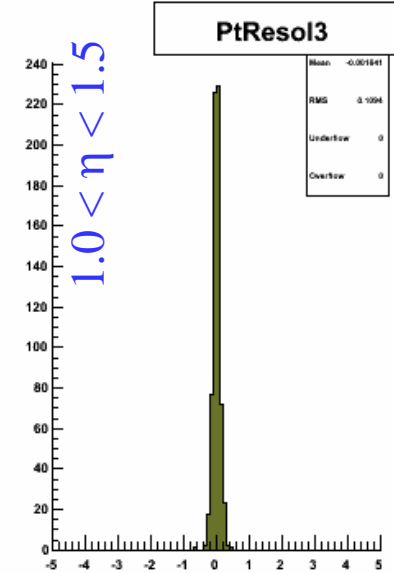
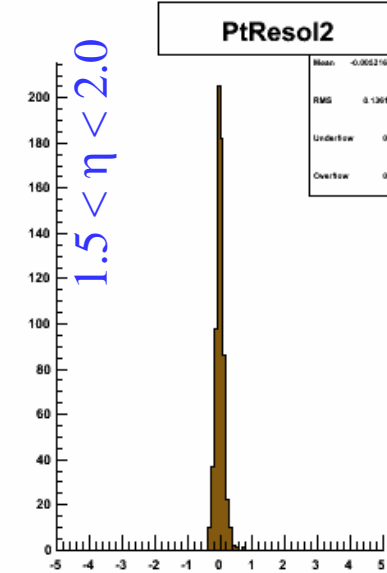
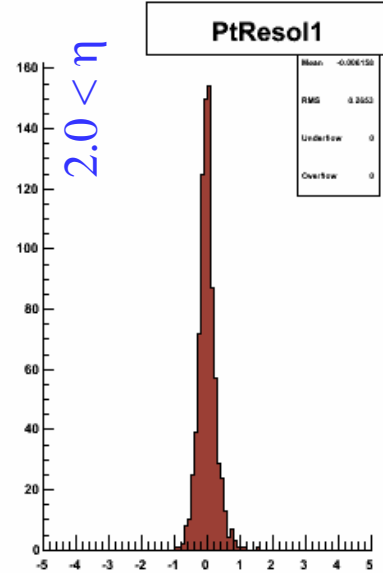

# 100 GeV electrons

- $p_T$  resolution.
- In central region:  
$$\frac{\sigma_{p_T}}{p_T} \sim 0.2.$$
- In forward region, there isn't any  $p_T$  resolution!

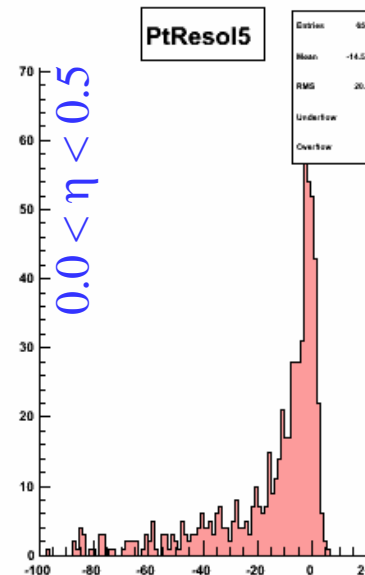
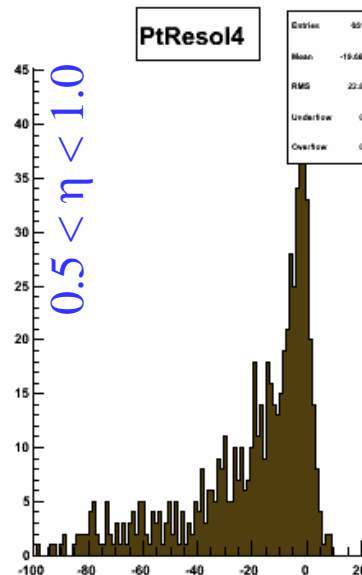
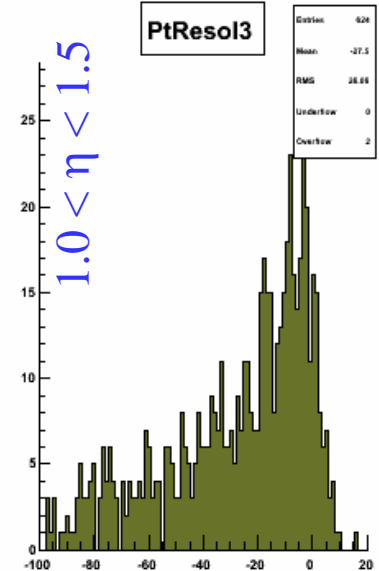
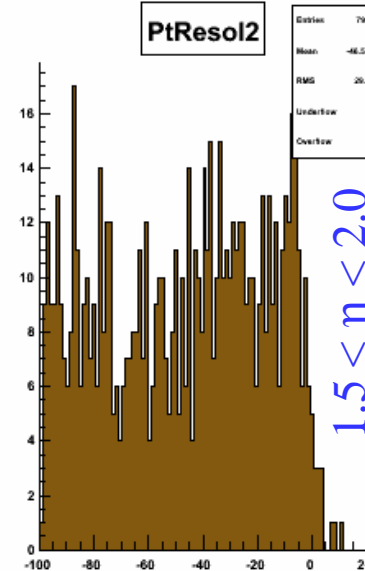
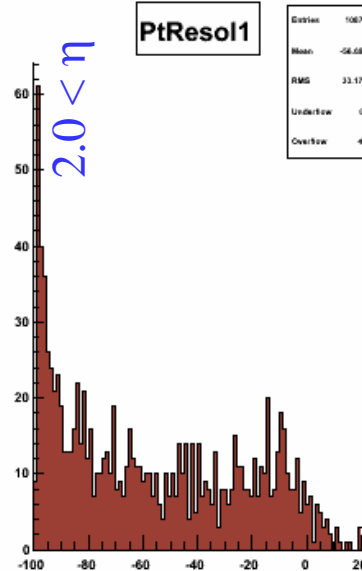

# 5 GeV electrons

- $p_T$  resolution.
- In central region:

$$\frac{\sigma_{p_T}}{p_T} \sim 0.15.$$

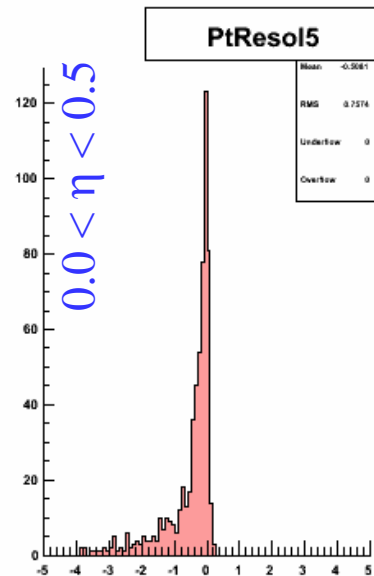
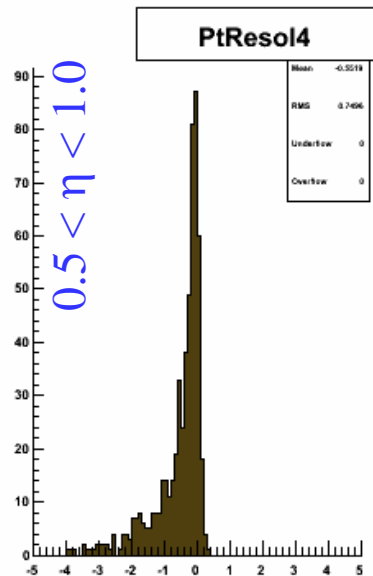
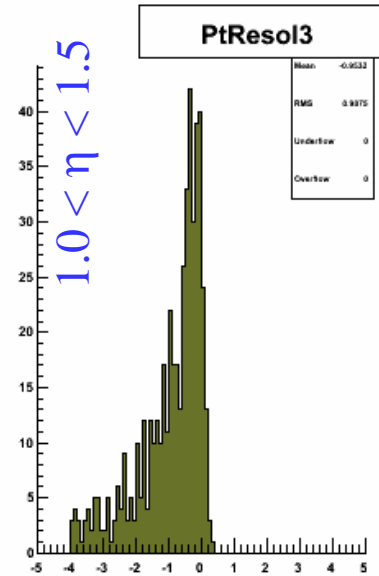
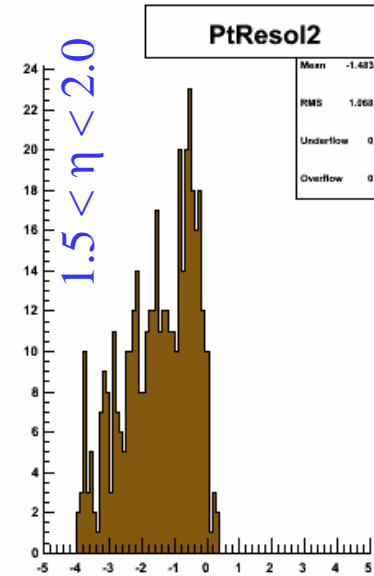
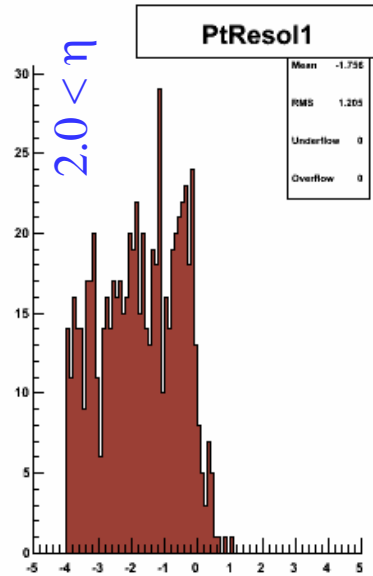



# 100 GeV muons

- Transverse impact parameter.
- In central region:  
 $\sigma_{d_0} = 0.008$  mm.
- In forward region:  
 $\sigma_{d_0} = 0.009$  mm.

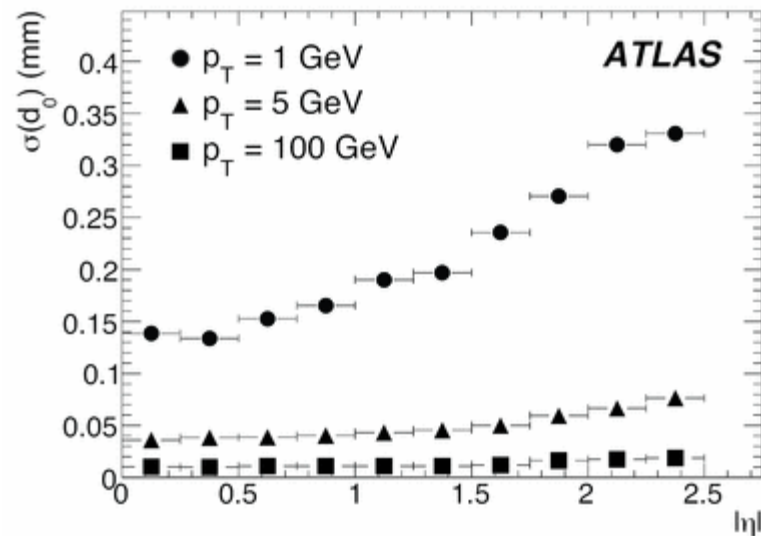
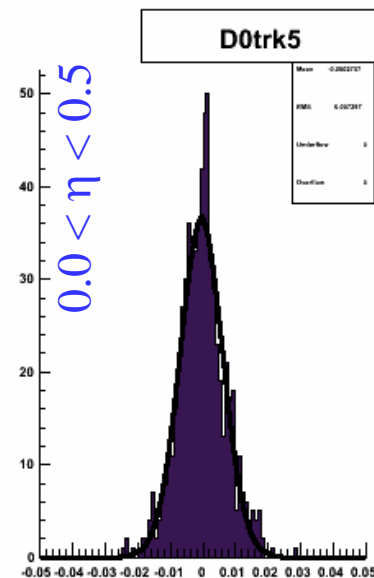
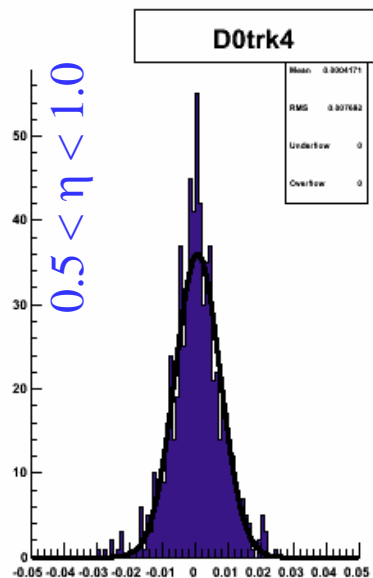
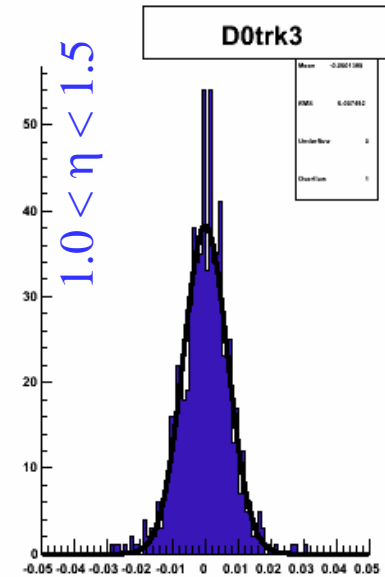
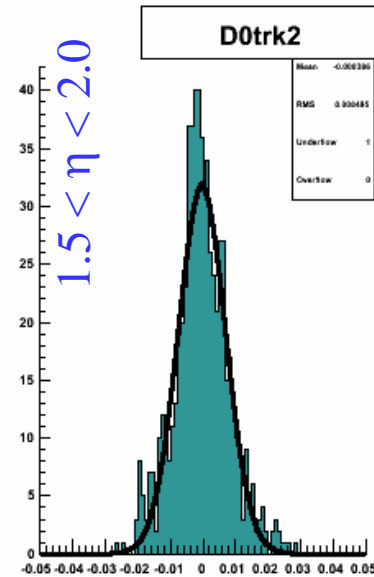
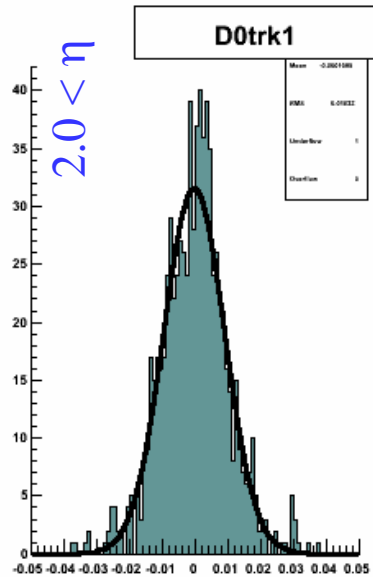

# 5 GeV muons

- Transverse impact parameter.
- In central region:  
 $\sigma_{d0} = 0.03$  mm.
- In forward region:  
 $\sigma_{d0} = 0.05$  mm.

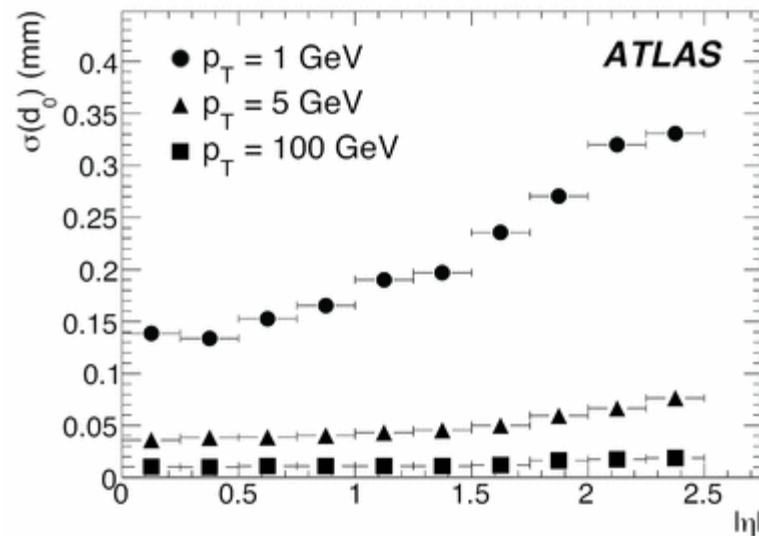
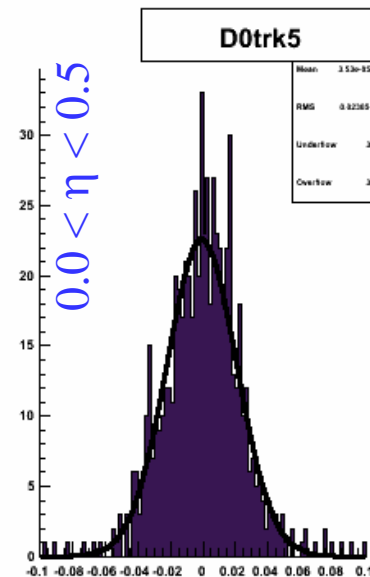
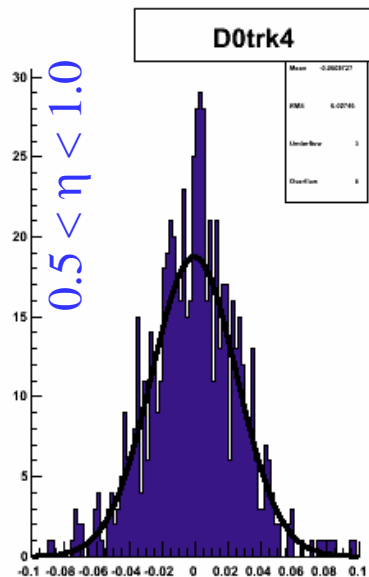
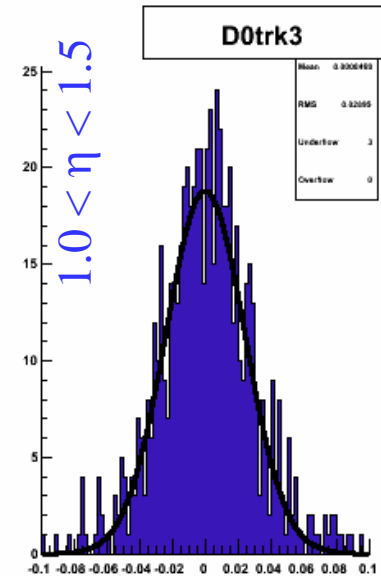
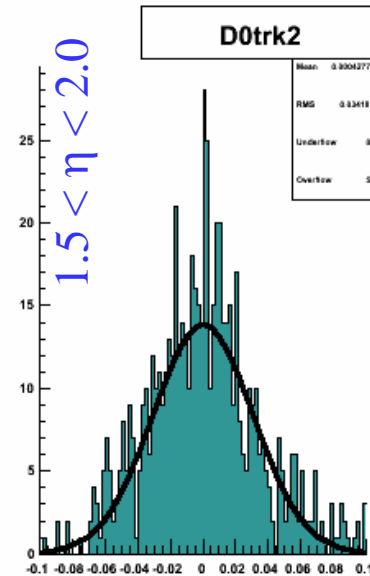
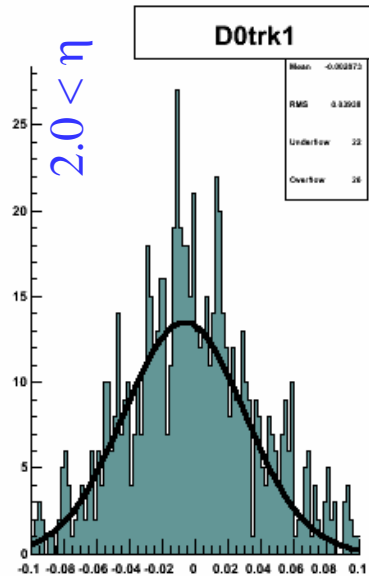

# 100 GeV electrons

- Transverse impact parameter.
- In central region:  
 $\sigma_{d0} = 0.05$  mm.
- In forward region:  
 $\sigma_{d0} = 0.07$  mm.

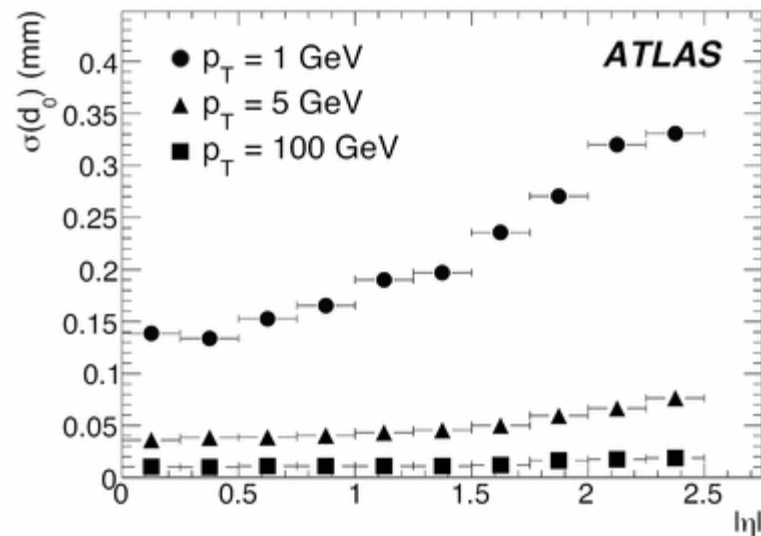
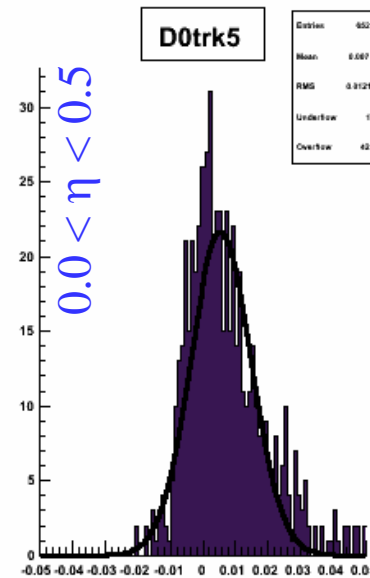
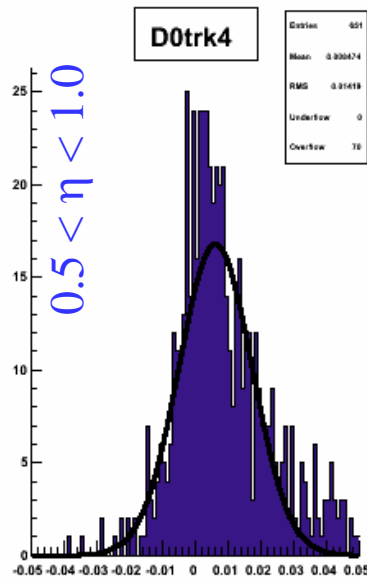
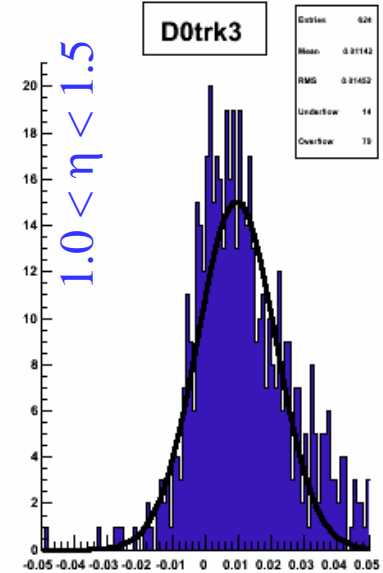
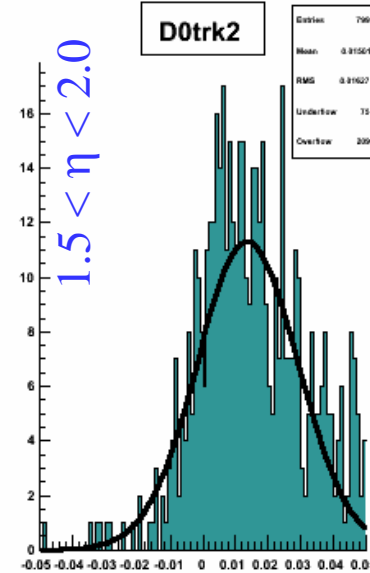
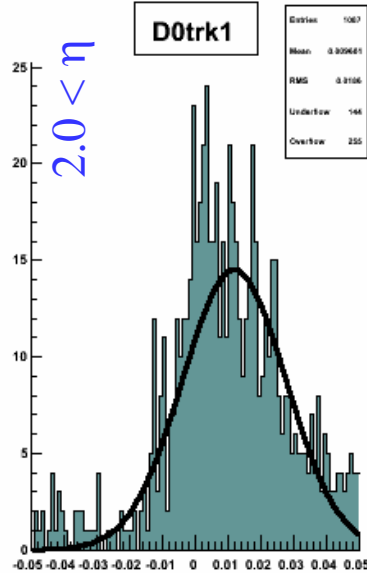

# 5 GeV electrons

- Transverse impact parameter.
- In central region:  
 $\sigma_{d0} = 0.04$  mm.
- In forward region:  
 $\sigma_{d0} = 0.05$  mm.

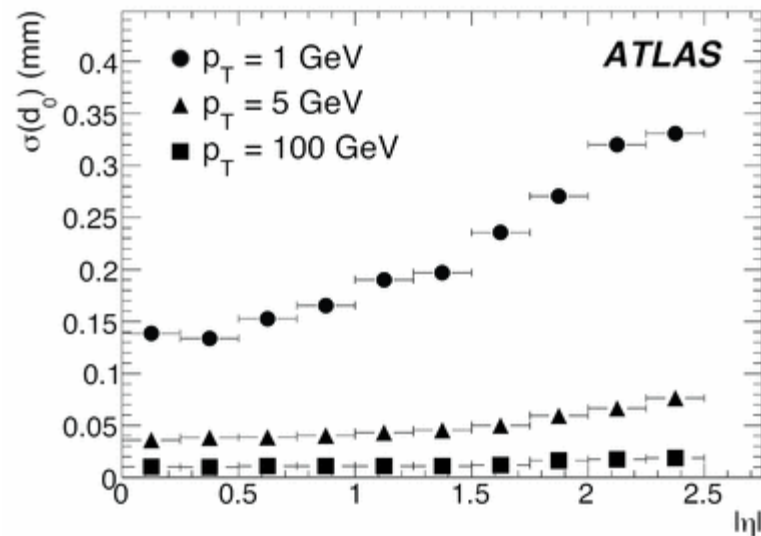
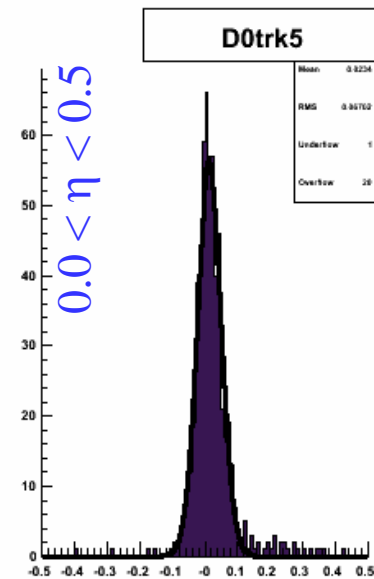
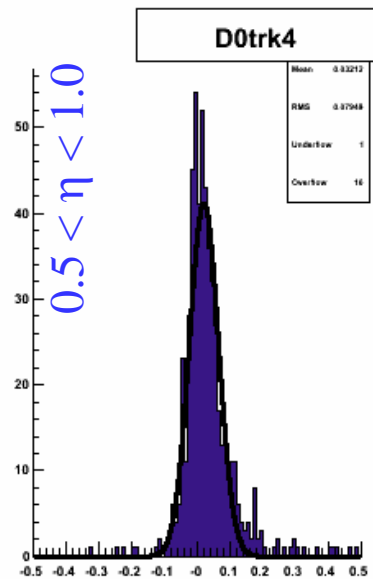
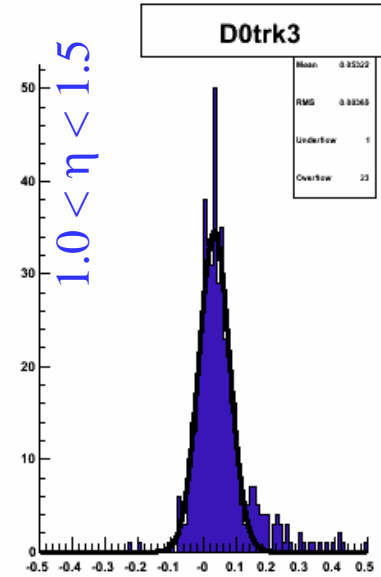
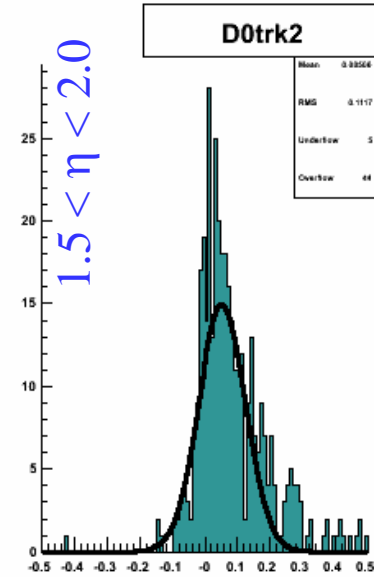
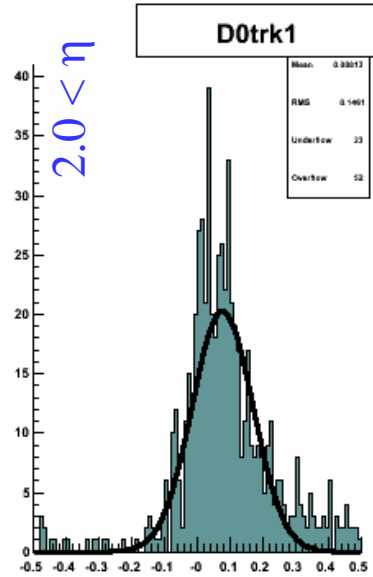

# 100 GeV muons

- Longitudinal impact parameter.
- In central region:  
 $\sigma_{z_0} = 0.05 \text{ mm}$ .
- In forward region:  
 $\sigma_{z_0} = 0.1 \text{ mm}$ .

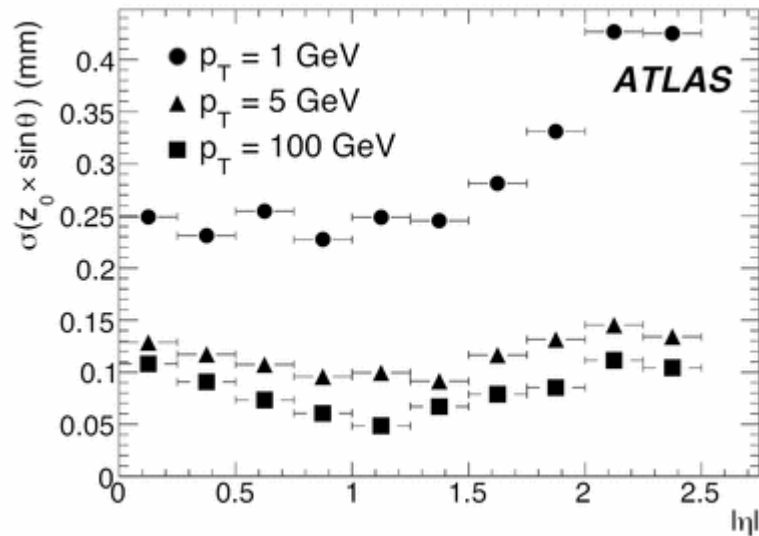
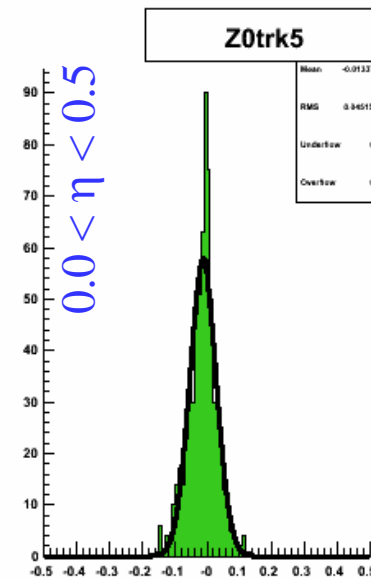
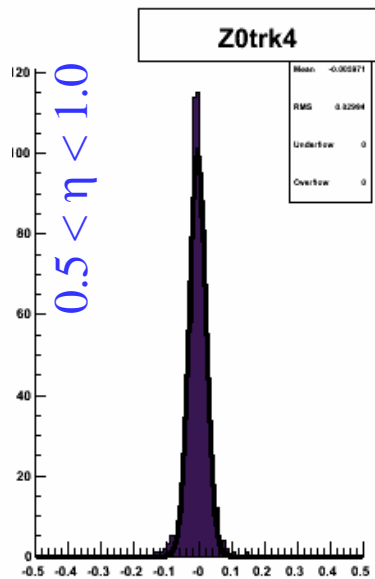
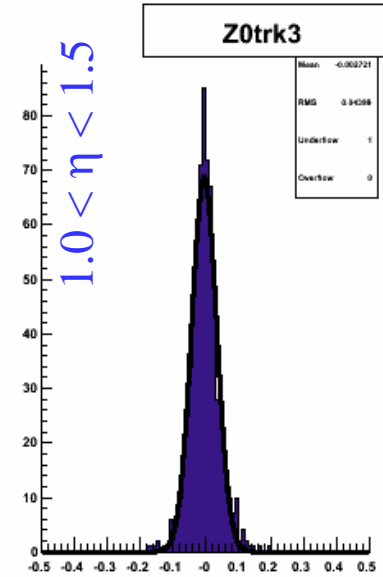
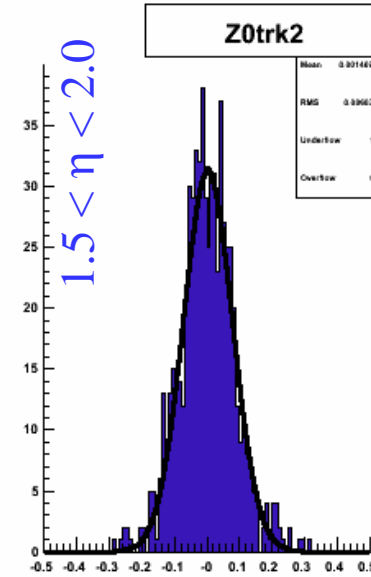
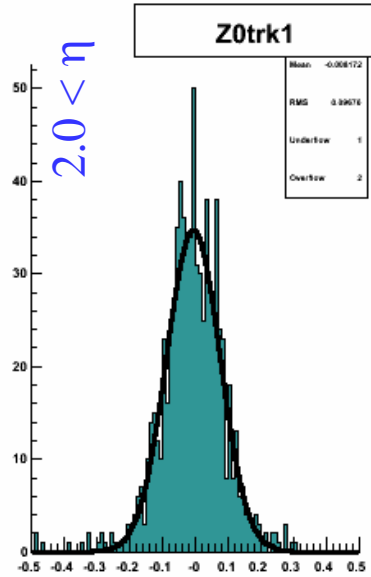

# 5 GeV muons

- Longitudinal impact parameter.
- In central region:  
 $\sigma_{z0} = 0.08 \text{ mm}$ .
- In forward region:  
 $\sigma_{z0} = 0.2 \text{ mm}$ .

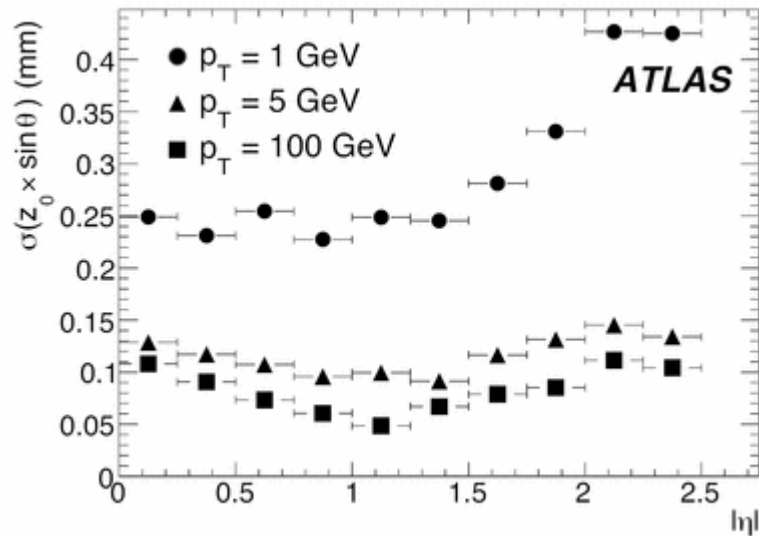
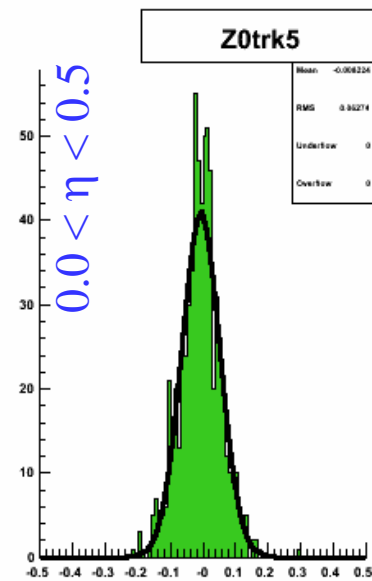
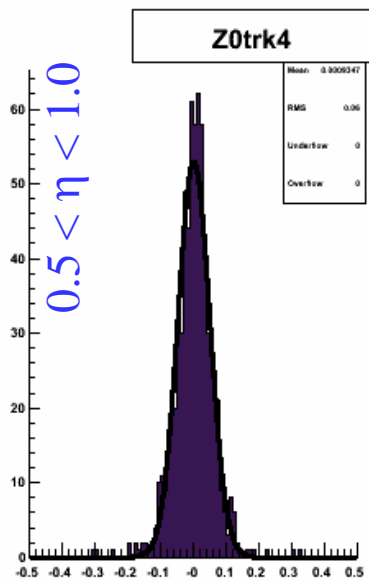
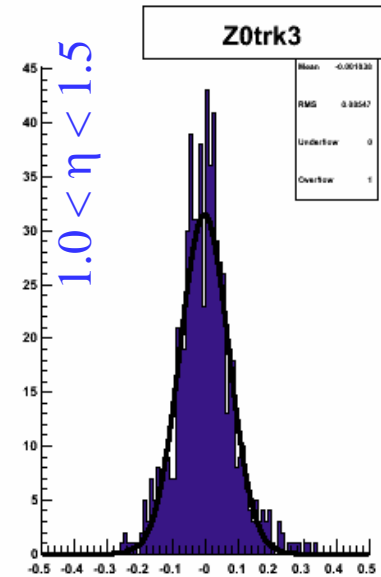
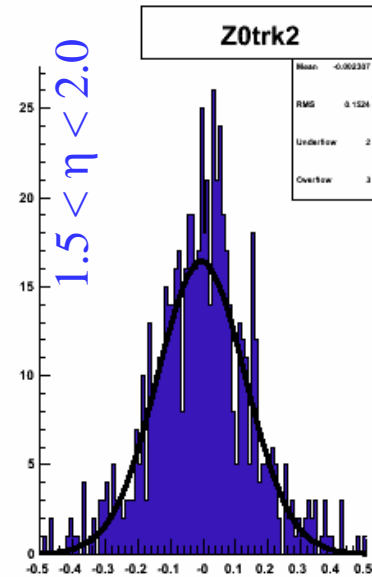
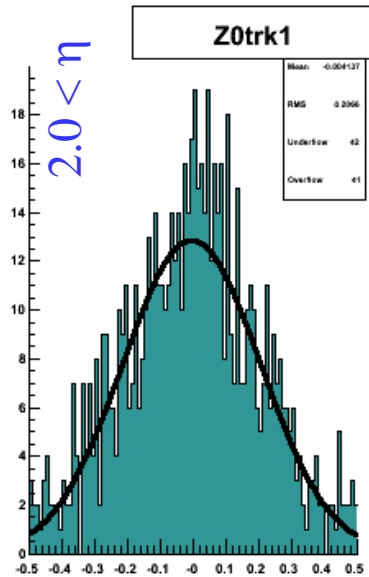

# 100 GeV electrons

- Longitudinal impact parameter.
- In central region:  
 $\sigma_{z0} = 0.06 \text{ mm}$ .
- In forward region:  
 $\sigma_{z0} = 0.1 \text{ mm}$ .

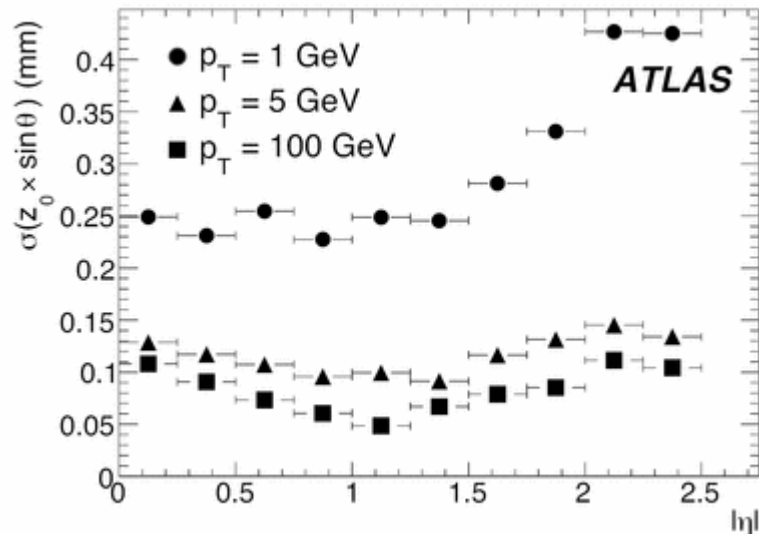
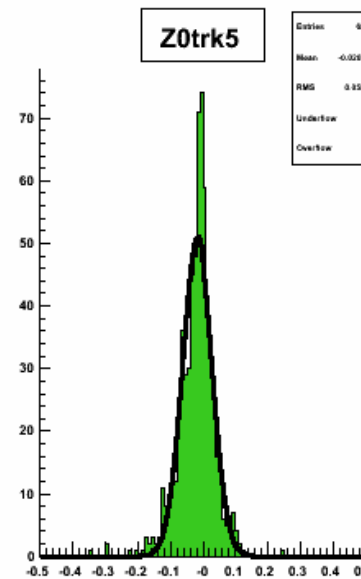
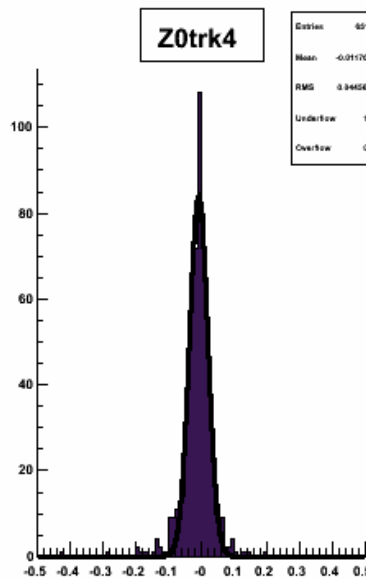
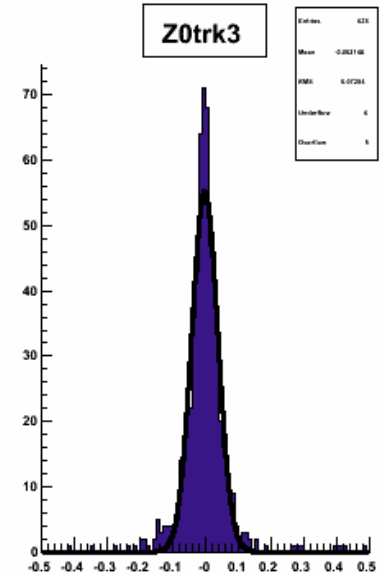
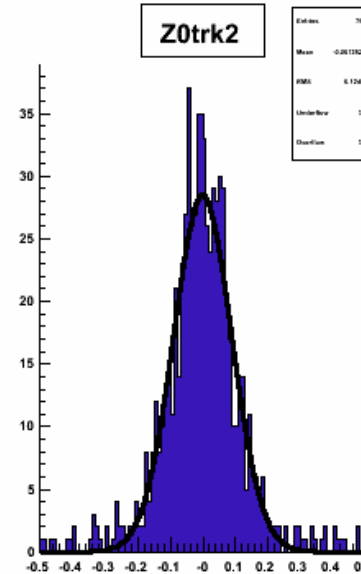
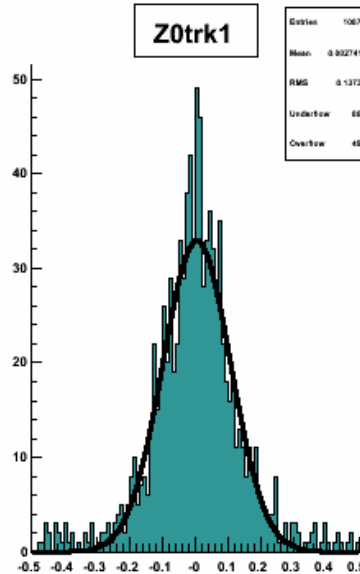

# 5 GeV electrons

- Longitudinal impact parameter.
- In central region:  
 $\sigma_{z0} = 0.09 \text{ mm}$ .
- In forward region:  
 $\sigma_{z0} = 0.3 \text{ mm}$ .

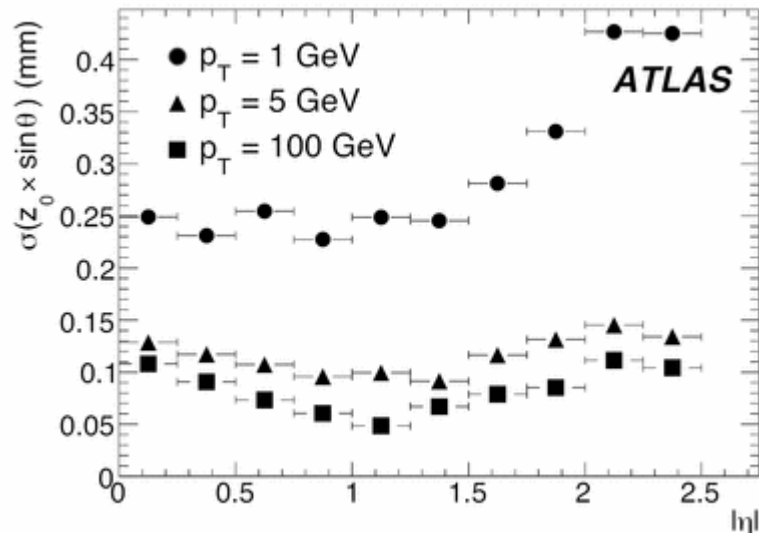
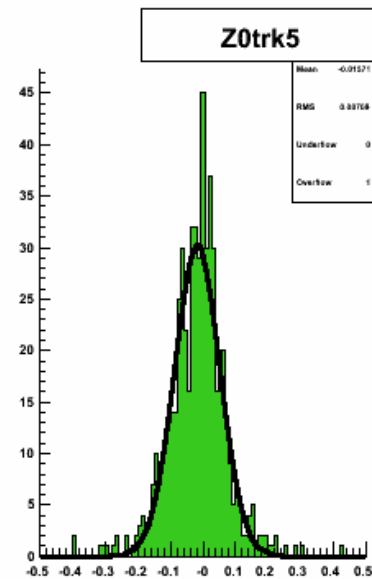
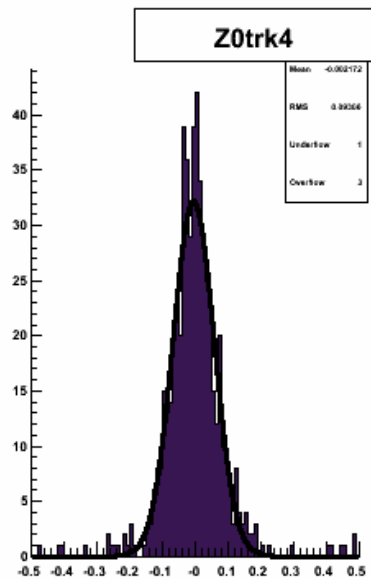
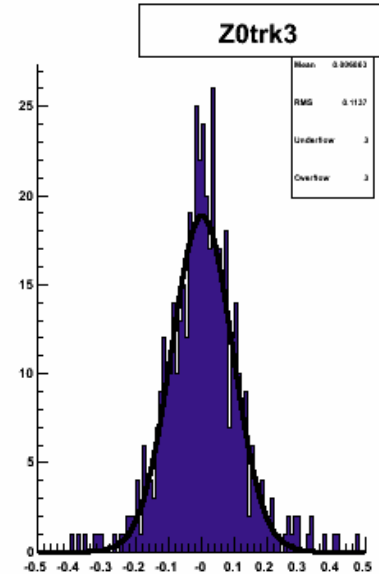
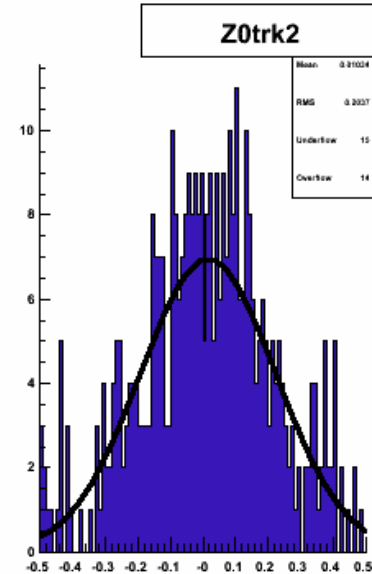
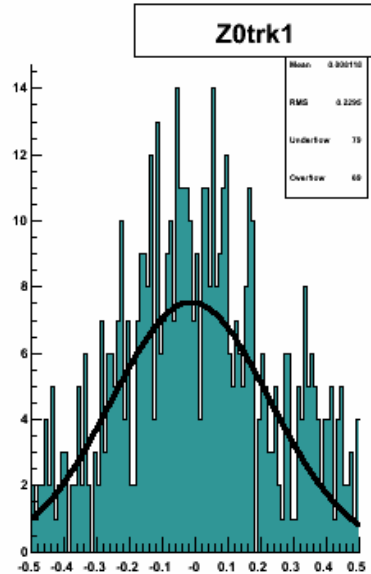



# Module material budget

- Simulate as stack of rectangles (Jo Pater).
- Top view:

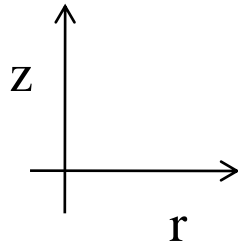
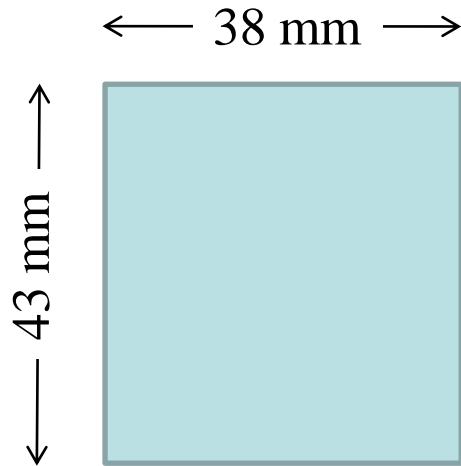

- Cross section:

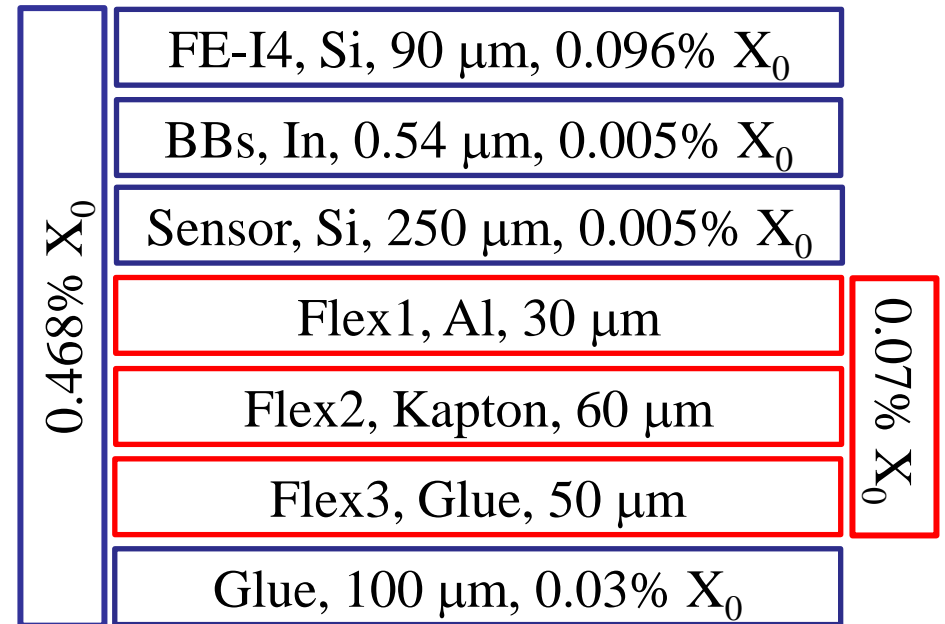

# Summary

---

- FATRAS (just about) works!
- Results for Utopia layout don't look crazy, but serious validation yet to be carried out.
- With above caveat, with the Utopia layout:
  - ◆ Muon  $p_T$  resolutions look similar to current tracker.
  - ◆ Electron measurements compromised by amount of material in forward direction.
  - ◆ It will be difficult to identify with which z vertex a high energy muon is associated when we have 400 interactions per bunch.
- Introducing the true lampshade geometry into FATRAS will not be easy.
- Can we come up with a cheat that will give us any idea about the expected performance of a “lampshade” tracker?
- Not sure what the material distribution in the FATRAS representation of Utopia is.
- Try to find out and look at consequences of changing this.